

# International Pole Sports Federation

## *Apparatus Norms 2020*



[www.polesports.org](http://www.polesports.org)

*Copyright © 2020 IPSF*

This document must only be used for competitions endorsed by the IPSF.



## Table of

### Contents

Introduction.....	3
Definitions of relevant parties: .....	3
1. Improving Apparatus.....	4
2. The Purpose .....	4
3. The Certificate .....	5
4. Quality and Guarantee .....	5
5. Apparatus Norms.....	5
5.1 The floor of the stage .....	5
5.2 The Stage.....	5
5.3 The pole .....	6
5.4 The Base.....	7
5.5 The Extender .....	7
5.6. Truss Fixings for Poles.....	8
5.7. The Aerial Hoop .....	8
5.8. Rigging of the Aerial Hoop .....	10
5.9. Safety Mat for aerial hoop .....	16
6. Truss and stage Standards .....	16
7. Testing .....	18
7.1. Retesting.....	20
8. Terms of Certification.....	21
8.1 Publication of Certificates.....	22
8.2 Validity of the Certificate .....	22
8.3 Rights of the Apparatus Manufacturer with a valid IPSF Certificate .....	22
8.4 Removal of certificate .....	22
9. FEES .....	23
9.1. Definitions:.....	23
9.2. Benefits of certification .....	24
APPENDIX I.....	25

## Introduction

The Apparatus Norms have been specifically created by the IPSF as an industry standard for manufacturers of Pole and Aerial equipment used during IPSF endorsed competitions. They will be developed over the next three years in order to test and improve the safety of equipment required at all IPSF events. Competition organisers follow a separate level of criteria for IPSF endorsement of a competition; part of these criteria is to use IPSF certified poles and aerial apparatus and industry certified truss/staging equipment. Truss/rigging/staging manufacturers and suppliers have industry related certifications for safety of equipment and installation; documentation must be provided to competition organisers for the competition to be endorsed.

The full document should be read in its entirety to give an overview of IPSF expectations of Apparatus Norms for IPSF endorsed competitions. However, please see below for the sections specifically relevant to competition organisers, pole and aerial apparatus manufacturers/suppliers and truss & rigging suppliers/installers.

### Definitions of relevant parties:

- *Competition organisers* refers to a competition organiser who is responsible for an IPSF endorsed competition at any level.
- *Pole and aerial apparatus manufacturers* refer to manufacturers and suppliers of poles and aerial apparatus to IPSF endorsed competitions at any level.
- *Truss, rigging and staging suppliers* refers to companies responsible for supplying and installing the necessary equipment to be used at an IPSF endorsed competition at any level.

<b>Sections most relevant to each party regarding Pole Sports</b>			<b>Aerial Sports</b>
<b>Competition Organisers</b>	<b>Pole Manufacturers/Suppliers</b>	<b>Truss/Rigging/Staging Manufacturers/Suppliers</b>	
1	1	1	5.7, 5.8, 5.9
2	2	4	
4	3	5.1, 5.2	
5.1, 5.2	4	5.6	
8, 8.1, 8.2	5.3, 5.4, 5.5	6	
	5.6		
	7, 7.1		
	8, 8.1, 8.2, 8.3, 8.4		
	9		

## **1. Improving Apparatus**

- The IPSF commitment to improving apparatus Norms within pole and aerial sports gives each athlete around the world the opportunity to train on the same safe equivalent apparatus. It also allows the technicians, organisers, and above all the apparatus manufacturers, to be updated on the latest developments in this important area.
- The apparatus Norms is an open working document that will be improved upon each year in a rapidly growing sport to keep up to date of the technological advancements within Pole and aerial Sport.
- This document is the result of a team effort led by the members of the IPSF, pole and aerial apparatus manufacturers and truss manufacturers.
- This document has taken in to consideration the IPSF Rules, Code of Points and that pole and aerial sports are new sports in its formative years, allowing room for development and growth.
- The IPSF would like to thank everyone who has contributed to the publication of this document.

## **2. The Purpose**

- The primary purpose of the IPSF apparatus Norms is to have equivalent apparatus at all competitions. It is essential for the competitors to have the same, optimal conditions for the preparations for competitions and at competitions all over the World. This is necessary for practical reasons, for competition fairness and comparison, and for safety.
- All apparatus used at IPSF endorsed events must have a valid IPSF Certificate. This Certificate will be issued by the IPSF, provided the apparatus has been tested successfully.
- The choice of grade of brass and steel material for poles and aerial equipment, construction and manufacture has been left to the manufacturers to allow the apparatus specifications to adapt to progress, development and new construction techniques. Therefore, the IPSF only prescribes measurements and functional properties for testing and testing procedures.
- The testing procedures must be constantly developed to ensure they stay relevant. It is important to develop testing procedures which guarantee that the apparatus meet the required standards after intensive use. To enforce the Apparatus Norms and to guarantee the quality of apparatus after intensive use, the IPSF may, before, during or after an event, control the apparatus and request retests.

### **3. The Certificate**

The specifications for this document were adopted by the IPSF Executive Committee in April 2015 and updated in February 2020 are valid from 1st February 2020. They replace all previous editions as well as all previous decisions and publications regarding apparatus from the Executive Committee and Technical Committees. They are compulsory for all IPSF endorsed events and only apparatus which has a valid IPSF Certificate may be used.

### **4. Quality and Guarantee**

To guarantee equal quality and fairness for the competitors and to guarantee their safety and health, testing procedures for the quality of apparatus are necessary. Those testing procedures follow below.

These apparatus norms and functional properties must not only be fulfilled at the time of the recorded test. The apparatus manufacturers must guarantee to produce their apparatus in such a quality that the apparatus also fulfil the requested Norms, functional properties and safety aspects after intensive use e.g. after a World Championships

### **5. Apparatus Norms**

#### **5.1 The floor or floor of the stage**

- The surface must be level, even and without gaps.
- The surface cover of the area should be dance flooring and provide a balance between anti-skid and slippage. It should not cause skin burns.
- The floor must not produce disturbing sounds during the execution of an exercise. It must assure a low noise level.
- The floor should be of plain colour which choice is left to the event organiser's discretion. Dark colours should be avoided. For certain events the IPSF may stipulate the colours.

#### **5.2 The Stage**

- The Performance Area must have a rectangle format.
- The stage must be connected firmly and must grip to the floor to prevent slipping.
- Distance between poles must strictly be 3m apart with a tolerance of  $\pm 100\text{mm}$
- The stage should be 10m wide and 6m deep with a tolerance  $\pm 1.5\text{m}$
- The elevation of the stage is the choice of the event organiser. However, this should be an acceptable height for judges to view fully. The stage may also be directly on the floor and without elevation.

### 5.3 The pole

- The apparatus consists of a one-piece (in length) brass tubular body which is placed vertically onto a base.
- The grade of brass tubing is left to the manufacturer's discretion, however the brass should not be electro-plated.

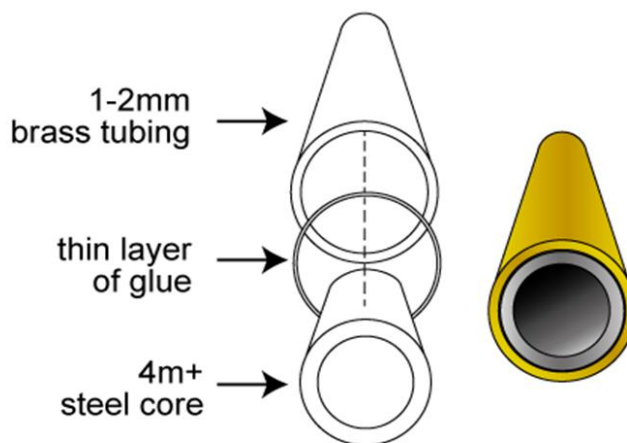

- Body Length 4000mm (excluding the extender) with a tolerance  $\pm 50$ mm.
- Body diameter is a constant 45mm.
- The pole must be steel lined for rigidity.
- External brass tubing diameter 2mm with a tolerance  $\pm 1$ mm
- Internal steel core diameter 4mm or more.
- The steel core should be firmly fixed to the internal wall of the brass tube. The anchoring to the body must assure immobility
- When the pole is correctly installed in a vertical position, a slight flexibility of the body (the tube), must not affect the support or stability of the pole is accepted, however this should not exceed 20mm lateral deflection of pole when in use; not to be confused with lateral movement of the truss system.
- The pole must have a high level of grip. The grip must be effective in all climates.
- The pole must not deteriorate with the use of grip enhancers.
- The metals used in the fabrication of the pole should not contain products that could cause an allergic reaction.
- The pole, its fixings, and all moving and working parts must be strong enough to withstand the lateral force of 180kg jumping at, and rotating on, the poles at speed.
- The pole should withstand the continued use of 180kg rotation and jump on for a period of 48 hours without bowing, slowing or damage to its working parts.
- The pole should function without noise from the moving parts.

## 5.4 The Base

- The base must serve as a support for the body of the pole.
- The base should not exceed more than 100mm in diameter unless previously approved by the IPSF.
- The base should be low profile. i.e. – with a depth of no more than 10mm
- No parts of the base may show sharp corners, edges, or fixings, nor rough surfaces.
- The base may have a minimum of 3 predrilled counter sunk screw holes.
- The base should be fixed to flooring with screws or industrial double-sided tape. If using screws, the screws should be 6mm in width and 40mm in length. They should fit flush to the base and covered if they present a hazard. An alternative method can be discussed prior to the event with the IPSF
- The static base should remain fully static during use.
- The spinning pole should flow freely, smoothly and without noise during use.
- The base must allow exact levelling of the body of the pole, and assure its immobility for the static pole and its free flow for the spinning pole.
- The manufacture must take in to consideration when designing the pole that the staging and rigging cannot be perfectly square. Therefore, the pressure may not be perfectly equal on the spin mechanism. For a heavier structure, the largest rigging configuration should be used
- The designs of the remaining parts are left to the discretion of the manufacturer.

## 5.5 The Extender

- The pole or its adjuster must tightly fit into the truss plate with a minimum of 50mm depth. The extender should have no lateral or vertical movement in its fixing.
- The extender rod should be securely fixed into the pole so that it can be extended without compromising the stability of the pole. The extender should sit in its screw thread 150mm  $\pm$ 50mm.

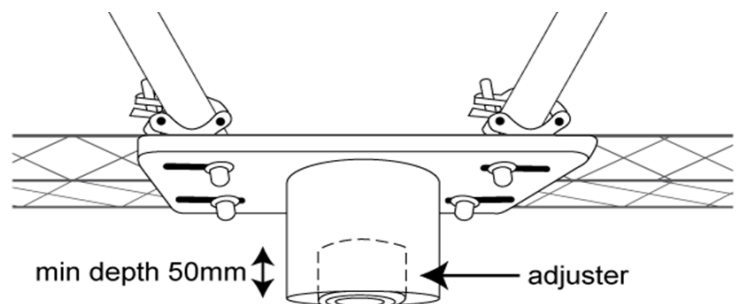

- The extender rod may be either bottom loading or top loading. If the pole is bottom loading, the extender must be covered virtually seamlessly so as to not cause the athlete(s) any injury. The cover must be in metal and withstand the above weights when applied.
- If the pole is top loading, there should be no more than 50mm of extender showing between the pole and the rigging point.

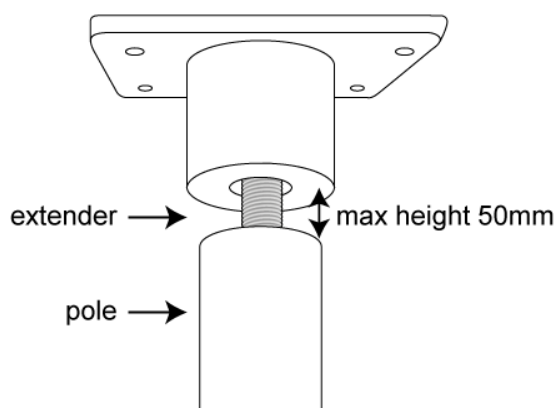

### 5.6. Truss Fixings for Poles

- The plate must fit a truss size from 250mm - 400mm.
- It must fix onto the rigging with a minimum of four fixing points.
- The fixings should be 4 burger clamps.
- All burger clamps must have safety certificates.
- The plate and or its fixings should be adjustable to fit different manufacturers of rigging.
- The rigging points must secure the plate to the truss with no movement
- If the plate is fixed to a separate coupling to insert the pole/extender into it should be fixed with a minimum of 4 bolts.

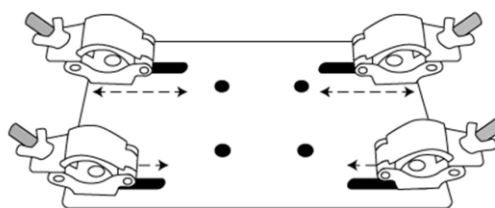

### 5.7. The Aerial Hoop

- The body of the hoop consists of a one-piece steel tube that forms an even ring shape. There must be 3 different diameters for the athletes to choose from. The sizes to choose between are either a 90cm, 95cm and 100cm diameter hoop with a tolerance of  $\pm 5$ mm. This measurement is taken around the outside of the hoop.
- The metals used in the fabrication of the hoop should not contain products that could cause an allergic reaction (like nickel, for example).



- The diameter of the tube is minimum 25mm and maximum 30mm.
- The tube can be of solid steel or a hollow steel tube, if the requirements for recommended working loads and the minimum weight of the apparatus are met.
- The minimum Working Load Limit (WLL) is 3kN and the minimum Breaking Load Limit (BLL) is 10kN.
- See the definition of the high bar, low bar and the sides of the hoop in the following diagram:
- If an adult (weighing a minimum of 80 kg) is hanging on the high bar of the hoop, the low bar of the hoop MUST NOT turn up more than 45 degrees.

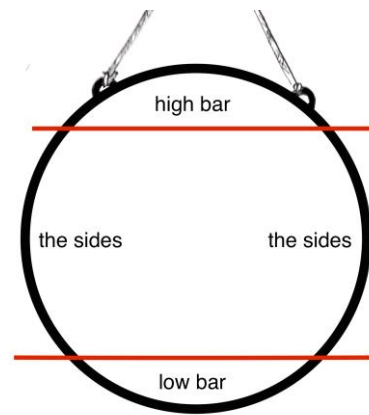

Acceptable



Unacceptable

- The surface of the hoop is powder coated, any colour.
- The use of tape (for grip) on the surface of the hoop is strictly forbidden. The hoop must be cleaned before every athlete.
- In IPSF endorsed competitions the aerial hoop must be a double point hoop (i.e. there are two rigging points) instead of a hoop with only one rigging point. See the example pictures.
- The hoop may have integrated rigging points (option 1 top diagram) or holes for attaching shackles (option 2 bottom diagram). Always follow the exact safety and rigging recommendations of the aerial hoop manufacturer regarding the shackles.
- The hoop must function without loud noise from the moving parts.

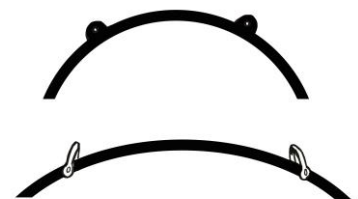

- The rigging points must be positioned on the high bar of the hoop. There must be enough distance between the points so that an adult person can comfortably sit between the points. The measurement of distance between the points is shown in the diagram below. Please note that A denotes the distance between tabs straight across the hoop, while B denotes the angle of the arc.

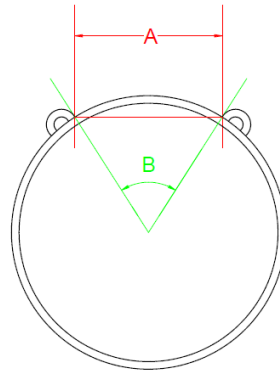

Hoop Size	Allowed Dimensions: A	Allowed Dimensions: B
90cm	45cm – 60cm	60° - 84°
95cm	45cm – 60cm	57° - 79°
100cm	45cm – 60cm	54° - 74°

### 5.8. Rigging of the Aerial Hoop

- A competent professional who is capable and familiar with rigging human loads must always be used to rig the aerial equipment. They must hold their own public liability insurance.
- The hoop must be rigged in the following order from truss to aerial hoop. The IPSF can provide a video to show this system being used if necessary:
  - 1 x Construction Lifting Sling (either 1.5m or 2m length)
  - 1 x Shackle (moused with cable tie/leather/string)
  - 1 x Spring gate Carabiner
  - 1 x Swivel
  - 1 x Spring gate Carabiner
  - Multiple construction lifting Slings for height changes at this point in the system (0.5m/1m/1.5m) - spare carabiners can be used to lengthen the system for small changes to length. This should be done on the top section, not below this.
  - 1 x Carabiner
  - 1 x Paw Plate
  - 2 x Carabiners
  - 2 x 80cm construction Lifting Sling

- 2 x Maillon (changing the hoop size can be done here to save having to buy multiple rigging points for each hoop, simply change the maillons onto the other hoop size and keep the rig complete)
- 1 x Hoop

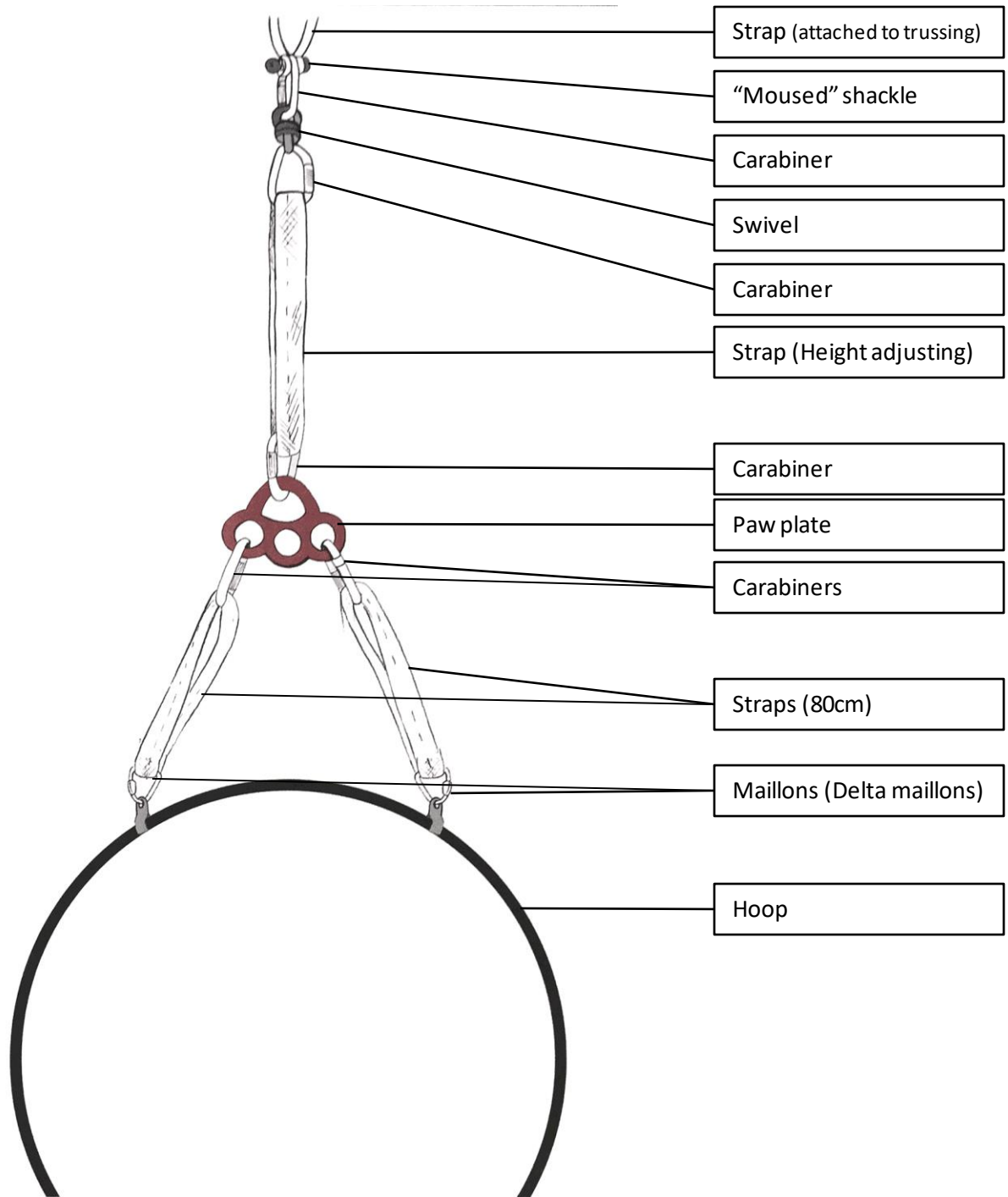

Rigging system

- Steel cables may not be used in this system. All of the slings, straps and/or ropes must have a certificate for a minimum of 23kN working load, and be clean and free of cuts or abrasion.
- Athletes must not touch the swivel system (or above it) at any time or they will be deducted, the swivel system is this section.

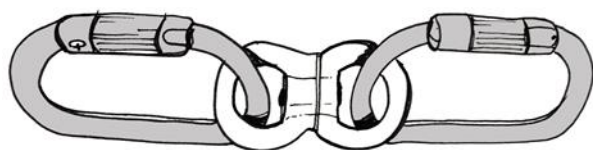

Image of Swivel

- It is very important that all equipment used is fit for purpose.
- When possible, a pulley system is the preferable method to use during competition, this allows various height changed to be done seamlessly without the need for climbing a ladder during competition. A pulley system must only be used by a competent professional person who is familiar with rigging human loads. This must be approved by the IPSF Aerial Team.
- The equipment required for the pulley system are as follows:
  - Descender for ground anchor, e.g. Petzl RIG or Petzl ID descender
  - 2 rescue pulleys
  - Static line 11mm, e.g. Black Marlow (NOT dynamic climbing-type rope)
  - 3 bow shackles (moused)
  - 3 construction straps, 1 or 2 tonne in either 1.5m or 2m length.
  - 3 carabiners, auto-lock preferable, screw gate is acceptable; all must be rated for human loads.
  - The static line should have a figure 8 or figure 9 knot at the terminal end, where the hoop will attach. The swivel section is added to this, followed by the paw plate, which in turn attaches to the hoop.
  - The descender end should be locked off as an added security with a knot and attached to the truss to terminate the system at the opposite end.

- If shackles or carabiners are used, they must be of a small size in order to prevent causing injury and distraction for the athletes (picture below), and must meet the minimum safety requirements of a WLL of 23kN.



Carabiner too large, not permitted

- The length of the straps/ropes must be 80cm so a triangle between the hoop and the rigging is formed, permitting the athlete to work on the high bar of the hoop, with additional length made up by the attachment maillons/carabiner (picture below). The entire system must be no shorter than 80cms so that a triangle between the hoop and the rigging is formed, permitting the athlete to work on the high bar of the hoop.

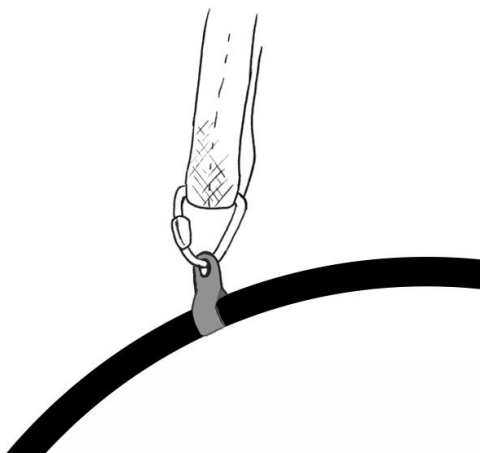

Triangular maillon attaching hoop to strap

- Both straps or ropes are connected to a carabine with quick lock system. All carabines must have safety certificates (CE stamp in Europe) and hold a minimum workload of 23kN. The material of the carabines should be stainless steel. The swivel can be of stainless steel or aluminium. The carabiner is connected to a swivel with a safety certificate, and a minimum breaking load of 35kN. Swivel permits the aerial hoop to spin and must never be prevented from spinning freely. All rigging hardware must be used within the manufacturer's parameters; they must be stored correctly and used only for the length of time that the manufacturer recommends.

- All components must be subjected to regular inspection to ensure safety and to identify any potential fatigue or degeneration of these components. Components found not to be in 100% working order must be replaced.
- The above is the minimum required by the IPSF in order to operate an Aerial Hoop competition. Please ensure that you consult your national regulations as well, to ensure that all legal requirements are met. Where there is a conflict between national regulations and IPSF requirements, please contact the Aerial team at [aerialsports@polesports.org](mailto:aerialsports@polesports.org).

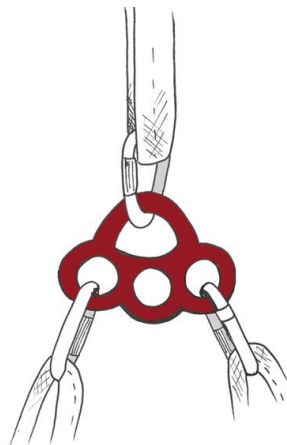

Paw plate at the bottom of the height changing strap

- For rigging the aerial hoop in pole sports competitions, the option two type pole sports structure must be used with an additional truss on top (picture 1, below). This truss can't be in the middle, since the truss unions should not be in the same place where the poles are rigged. The extra truss for the aerial hoop must be a minimum of 80cm behind or front of the poles. This will allow enough safety distance between the poles and the aerial hoop. The poles can be kept in the structure at the same time as the aerial hoop.

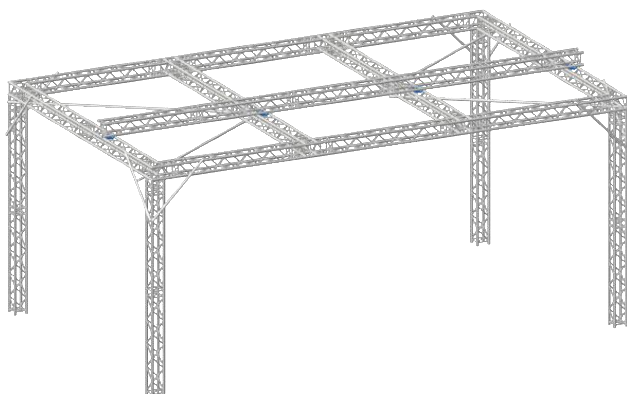

1 Truss System Hoop  
Scale: 1:50

Picture 1

- The hoop is rigged to the structure with a round construction strap in the following way (picture 2 or picture 3). One wrap is used for avoiding the point from moving. The construction strap should be a minimum of 1 tonne working load, and be clean and free of cuts or abrasion.

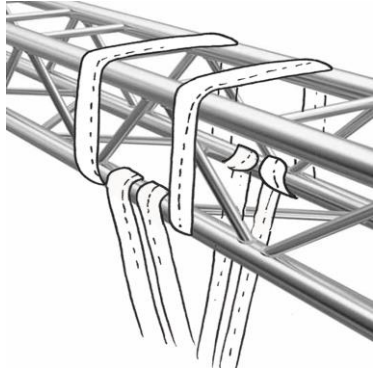

Picture 2



Picture 3

- Regulating the height for the aerial hoop: The organiser must offer several height options for the athletes to be able to choose the height they wish to perform. The height must be a minimum of the chin height of the athlete, and maximum that the athlete can reach the hoop with a small jump. This height is changed by having construction round slings of different lengths between the truss and the hoop. They can be used in the following ways for changing height. (picture below).

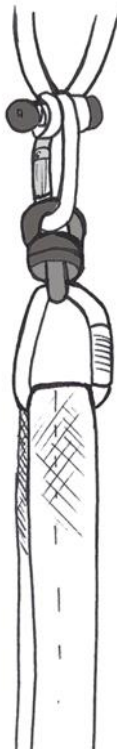

Shackle to height changing strap

### **5.9. Safety Mat for aerial hoop**

An area of 2m x 2m directly below the hoop must be covered with a gymnastics mat in case of the unlikely of a fall. It can be one mat, or two separate mats that are securely joined to prevent the mat moving and/or separating. The mat/mats must be a minimum of 4cm thick with tolerance of  $\pm 1$ cm and should have a non slippery backing to prevent the mat slipping. The mats need to be dense enough so that floor work can be executed, but soft enough to absorb a fall.

## **6. Truss and stage Standards**

- The truss cross section used must have a width of be between 300mm - 400mm.
- The truss should accommodate the full height of the 4m poles as well as its fixings
- The truss should accommodate the width of the standard size of the stage. This will vary depending on the manufacturer of the truss.
- The truss should be an IPSF standard configuration. Please see diagrams below.
- The truss must include all bracing shown in the diagrams below.
- The truss should have no more than 30mm lateral movement. If movement is in excess of 30mm further bracing/strapping should be applied to the truss to increase the stability. This is the responsibility of the rigging company. If using a Lupit Pole only configuration 2 can be used as this does not require extra weight to be braced.
- The truss system must have rubber foot plates on all four corners to prevent slippage.
- The horizontal truss where the rigging plate fixes should not have a joint attaching two pieces of truss together. This will interfere with fixing the truss plate to the horizontal truss.
- All truss pieces must be bolted together in the correct way and not tied together with webbing.
- If using option 1 or option 3, the system must be strapped down in line with the vertical truss and weighted down with a minimum of 100kg of weight on each side of the truss. This should be increased if the truss has exceeded the maximum lateral movement allowance. Full bracing needs to be used in each corner as indicated in red on the diagram.



**Option 1**

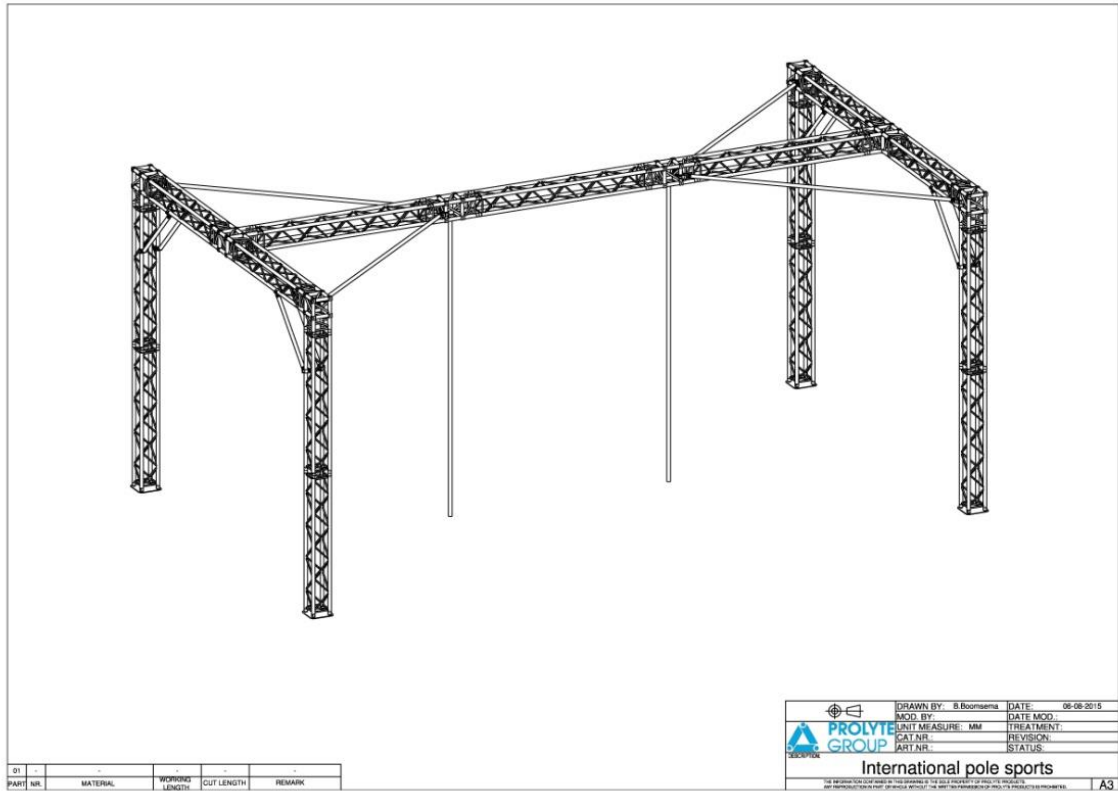

**Option 2**

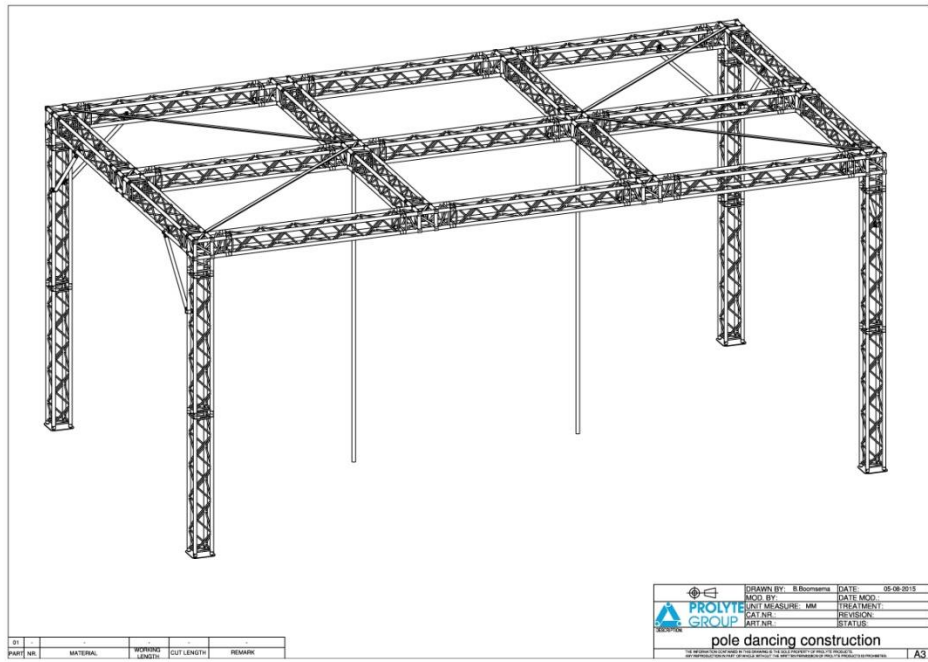

### Option 3

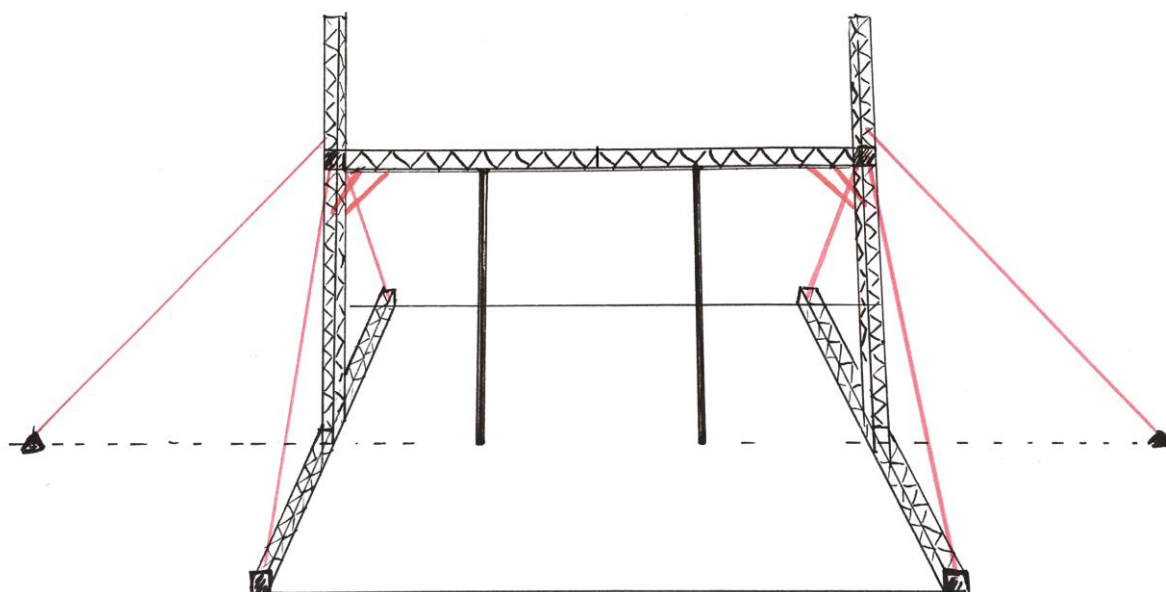

## 7. Testing

As pole and aerial sports are in their infancy, technical knowledge and expertise does not currently extend further than our own industry. There currently is no IPSF approved testing facility to test the safety and security of IPSF certified apparatus or any ISO standards. Therefore, the IPSF have set out the following guidelines for manufactures to test their equipment for certification.

*The pole manufacturer must provide a **video presentation in English** of the following:*

- Clear visible and audible footage of testing in English.
- The test must be completed at full height, however if a truss and stage cannot be erected the pole can be used on two fixed upper and lower points. I.E a ceiling and floor. Please be advised that it is expected that the pole should be tested on a truss prior to competition .
- The test should be conducted with all pole working parts this includes the base of the pole and the truss plate as well as the full body of the pole.
- Show the base of the pole showing the size of the base against a tape measure.
- A cross section of the pole showing the external brass tube and its inner steel tube fixed together.
- Show the cross section of the pole showing the diameter against a tape measure.
- Show the length of the pole against a tape measure. Show the full one -piece pole.
- Show how the locking system from static to spinning and back to static functions.

- Show the full extender against a tape measure and show how the extender fits into the pole.
- Show the truss fitting and how it fits to the pole and the truss.
- A full demonstration on how to install the pole to the truss and the stage, clearly pointing out problems that could occur during installation and how to combat them.
- Show the pole on static and on spinning both with force once the pole has been correctly installed.
- Show the pole under continued force using the weights below for a period of 4 minutes on each pole. We understand that you cannot show the pole for 48 hours however it should be understood that the pole should be privately tested under the weight conditions below.
- The pole should keep its integrity after this test has been completed. Meaning that the pole and its working parts should not have been compromised in any way. The body of the pole must continue to be 100% straight and all working parts moving correctly.
- To show the pole, its fixings and all moving and working parts to be strong enough to withstand the lateral force of 180kg jumping at and rotating on the poles at speed.
- To explain how the pole is proven to withstand the continued use of 180kg for a period of 48 hours without bowing, slowing or damage to its working parts.
- The pole should function without noise from the moving parts.
- A written statement should accompany the test video. This written statement must include the following:
  - “We confirm that the construction of the apparatus and the functional properties has been tested in accordance to the IPSF Norms.” “We confirm that the apparatus has been tested under competition conditions and that the integrity of the equipment after testing has not been affected.”
  - The IPSF may require a retest or refuse the re-certification.
  - The cost of the testing will be the sole responsibility of the manufacturer.
  - This testing criteria may be changed at any time but the IPSF to improve testing conditions. All testing videos will remain confidential.

*The hoop manufacturer must provide a **video presentation in English** of the following:*

- *Clear visible and audible footage of testing in English.*
- *A full demonstration on how to install and use the hoop to the truss and the stage, clearly pointing out problems that could occur during installation and how to combat them.*
- *Show the hoop under continued force using the weights below for a period of 4 minutes. We understand that you cannot show the hoop for 48 hours however it should be understood that the hoop should be privately tested for the required BLL and WLL.*

- *The hoop should keep its integrity after this test has been completed. Meaning that the hoop and its working parts should not have been compromised in any way*
- *A written statement should accompany the test video. This written statement must include the following:*
- *“We confirm that the construction of the apparatus and the functional properties has been tested in accordance to the IPSF Norms.” “We confirm that the apparatus has been tested under competition conditions and that the integrity of the equipment after testing has not been affected.”*
- *The IPSF may require a retest or refuse the re-certification.*
- *The cost of the testing will be the sole responsibility of the manufacturer.*
- *This testing criteria may be changed at any time but the IPSF to improve testing conditions.*
- *All hoops should be fully strength tested and should come with some sort of paperwork that ideally shows certificates of conformity.*
- *All testing videos will remain confidential.*

#### **7.1. Retesting**

- If the construction of the apparatus or the functional properties has changed, the apparatus has to undergo a practical retest (see above criteria).
- In case of small modifications which do not affect the functional properties or would not lead to a different test results, the IPSF may dispense the apparatus manufacturer from testing. In cases of doubt, the IPSF takes a final decision in consultation with the IPSF executive committee
- To renew a certificate, the apparatus manufacturer must send a request to the IPSF. This request must include the following three statements:
  - *“We confirm that the construction of the apparatus and the functional properties have not changed since the last successful test.” “We confirm that the materials used are the same and have the same functional properties as those used for the last successful test.” “We confirm that our apparatus has been adapted to the apparatus Norms valid today.”*
- The IPSF may require a retest or refuse the re-certification.

## 8. Terms of Certification

- The IPSF certification of a product does not include sponsorship of any IPSF competition or event at regional, national, continental or global level. Sponsorship must be negotiated separately with the event organiser.
- The certification is only given by the IPSF and not IPSF national federations or event organisers.
- The certification is for three years from certificate date.
- Payment details will be provided by invoice, and certification will not be approved until the payment has been agreed.
- The IPSF endorsed logo can only be used in relation to the certificated product and cannot be used to endorse the business or any other product not approved by the IPSF.
- Should a manufacturer no longer wish to have IPSF certification for their product or their certificate has been revoked or lapsed, they must cease using the IPSF certification and respective logos with immediate effect. This includes, but is not limited to, destroying any packaging and promotional material as well as removing the IPSF branding and name from their website and social media.
- The poles or aerial apparatus should arrive at competitions a minimum of a week prior to the competition set up day, unless otherwise agreed with the competition organiser
- The poles or aerial apparatus must come with clear instruction and a complete list of components needed to set up the pole or aerial apparatus, unless the manufacturer is sending a technician to either install or assist with installing the apparatus.
- The poles or aerial apparatus should arrive with any specific tools required for installation unless the manufacture is sending these with a technician to either install or assist with installing the apparatus.
- All poles and aerial apparatus must have product liability insurance. This must be of a value acceptable to the countries of installation.
- All pole and aerial sponsors must discuss with the event organiser a minimum of 30 days prior to the event set up regarding the stage requirements for both parties. If the staging does not meet IPSF requirements due to logistics, both the event organiser and the pole sponsor must contact the IPSF to discuss requirements.

### **8.1 Publication of Certificates**

The IPSF regularly publishes a list of the valid Certificates including the period of validity.

### **8.2 Validity of the Certificate**

The Certificates have a validity of three years. The expiry date is indicated on the certificate. The IPSF may, at any time, prolong or shorten the validity of issued Certificates or withdraw a Certificate.

### **8.3 Rights of the Apparatus Manufacturer with a valid IPSF Certificate**

When receiving an IPSF Certificate, the apparatus manufacturer obtains the following rights:

- The right that the respective apparatus may be used at IPSF endorsed events.
- The right to use the designation and the logo «IPSF Certificated» together in the catalogue and other publicity material, as prescribed in the respective directives
- The use of the «IPSF Certificated» Logo on the respective apparatus.
- The regular publication in the list of certified apparatus on the IPSF website.
- The right to be a member of the IPSF Apparatus Commission (2 partners at a time)

### **8.4 Removal of certificate**

#### *Waiver of Liability*

With these Apparatus Norms, the IPSF, its member federations and recognised competitions, are in no way responsible for the apparatus. The IPSF, its member federations and recognised competitions waive all liability in connection with the use of apparatus described in these Apparatus Norms. Responsibility and liability in relation to the apparatus remains with the manufacturer/supplier.

*Please see the table at the end of the document in Appendix I for a full breakdown of penalties and sanctions.*

**It is the sole responsibility of the manufacturer to:**

a) Have in-depth experience and knowledge of the design, manufacture and installation of poles or aerial apparatus for competitions.

b) Provide safe and secure poles and aerial apparatus designed to IPSF apparatus norms.

The IPSF reserves the right to revoke the certification, ban a manufacturer/supplier and enforce a fine for, but not limited to, the following infringements:

- The IPSF has the right to test apparatus before, during and after competition for integrity.

## **9. FEES**

### **9.1. Definitions:**

#### *Band*

This refers to the geographical area of certification.

- Band 1/Regional - This refers to IPSF endorsed competitions at a local regional area or as a one-off endorsement for a national competition.
- Band 2/National - This refers to all areas within one specified country.
- Band 3/Global - This refers to world-wide coverage.

#### *Certificated/certification*

A company that has IPSF equipment certification has been certified by the IPSF having reached the standards required to supply or sell poles or aerial apparatus under the IPSF Partner Programme.

- *Advancement of certification* - Companies may advance certification on renewal to include a new geographical area.
- *Period of certification* – length of time IPSF certificate is valid.
- *Renewal of certification* - Certification is initially awarded for a period of three years unless the endorsement is for a one-off competition.
- *Terms of certification* – A, B, C refer to specific terms of certification awarded (See below).

#### *Sponsor/sponsorship/sponsoring*

To provide IPSF certificated poles or aerial apparatus including the means to install them correctly to an IPSF endorsed competition without payment.

## Sell

Companies certificated to sell IPSF competition poles and aerial apparatus within an allocated geographical area.

<b>FEES POLE</b>	<b>Band 1</b>	<b>Band 2</b>	<b>Band 3</b>
<b>Area</b>	Regional	National	Global
<b>Benefits of certification</b>	A	B	C
<b>Annual fees</b>	£500	£1000	£3000
<b>FEES HOOP</b>	<b>Band 1</b>	<b>Band 2</b>	<b>Band 3</b>
<b>Area</b>	Regional	National	Global
<b>Benefits of certification</b>	A	B	C
<b>Annual fees</b>	£150	£200	£250

### 9.2. Benefits of certification

- A. **Regional/one-off** - Certified to sponsor regional IPSF endorsed competitions by providing IPSF certified poles and/or aerial apparatus.
- B. **National** - Certified to sponsor regional and national IPSF endorsed competitions within the specified country of certification by providing IPSF certified poles and/or aerial apparatus. Certified to sell IPSF certified competition poles and aerial apparatus within the specified country.
- C. **Global** - Certified to sponsor IPSF endorsed competitions world-wide including the WPSC by providing IPSF certified poles and/or aerial apparatus. Certified to sell IPSF certified competition poles and aerial apparatus world-wide.

In order to apply for your apparatus to be certified by the IPSF please contact [info@polesports.org](mailto:info@polesports.org)



## APPENDIX I

Offence	Penalties	Removal of Certification	Immediate removal of IPSF logo	Re testing	Ban	Fine
A product deemed unsafe		✓	✓	✓	1 year	£2000
Misuse of the IPSF certification and the IPSF logos	Publication of the sanction. Manufacturer informs clients of infringement.	✓	✓		1 year	£2000
Selling and/or offering certified apparatus without a valid certificate (certificate expired)	Publication of the sanction. Manufacturer informs clients of infringement.	✓	✓		1 year	£2000
Selling and/or offering certified apparatus without a valid certificate (certificate expired)	Publication of the sanction. Manufacturer informs clients of infringement.	✓	✓		1 year	£2000
Testing an apparatus and selling and/or deliberately offering a different apparatus or construction or modified apparatus than the tested equipment.	Publication of the sanction. Manufacturer informs clients of infringement.	✓	✓		1 year	£2000
Selling, renting, sponsoring, offering, delivering, installing etc, non-certified apparatus (not certified at all, expired certificate or different apparatus from the tested one) for use at an IPSF event and events where IPSF Certified equipment is required.	Publication of the sanction. Manufacturer informs clients of infringement. Immediate rectification whenever possible	✓	✓		1 year	£2000
Using the abbreviation IPSF in any way for non IPSF certified apparatus, suggesting or giving the wrong impression of a relationship with IPSF.	Immediate stop of action, rectification and notification of the customers with copy to the IPSF. IPSF may notify customer(s) Written warning					
Same as above 2nd offence	Publication of the sanction					
Using the IPSF logo without being an IPSF partner	Immediate stop of action. Rectification and notification of the customers with copy to the IPSF. Written warning.					

Offence	Penalties	Removal of Certification	Immediate removal of IPSF logo	Re testing	Ban	Fine
Same as above 2nd offence	Immediate stop of action. Rectification and notification of the customers with copy to the IPSF. Written warning. Publication of the sanction.					£5000
Not using the IPSF Approved logo directly attached to the respective product, thus giving the impression that other non-certified products could also be IPSF Approved.	Immediate stop of action. Rectification and notification of the customers with copy to the IPSF. Written warning.					
Same as above 2nd offence	Immediate stop of action. Rectification and notification of the customers with copy to the IPSF. Written warning. Publication of the sanction.					£5000
Giving the impression of IPSF approval or certification by using misleading wording such as e.g. "meets IPSF specs", or "following IPSF rules" or similar.	Immediate stop of action. Rectification and notification of the customers with copy to the IPSF. Written warning.					
Same as above 2nd offence	Immediate stop of action. Rectification and notification of the customers with copy to the IPSF. Written warning.					£1000
Bringing the name of the IPSF or pole sports into disrepute	Written Warning	✓			2 years	
NOT FOLLOWING OR RESPECTING SANCTIONS.	Action and further sanctions to be taken at the discretion of the IPSF					